

Alpha[®] High-Speed Angle Grinder Instruction Manual

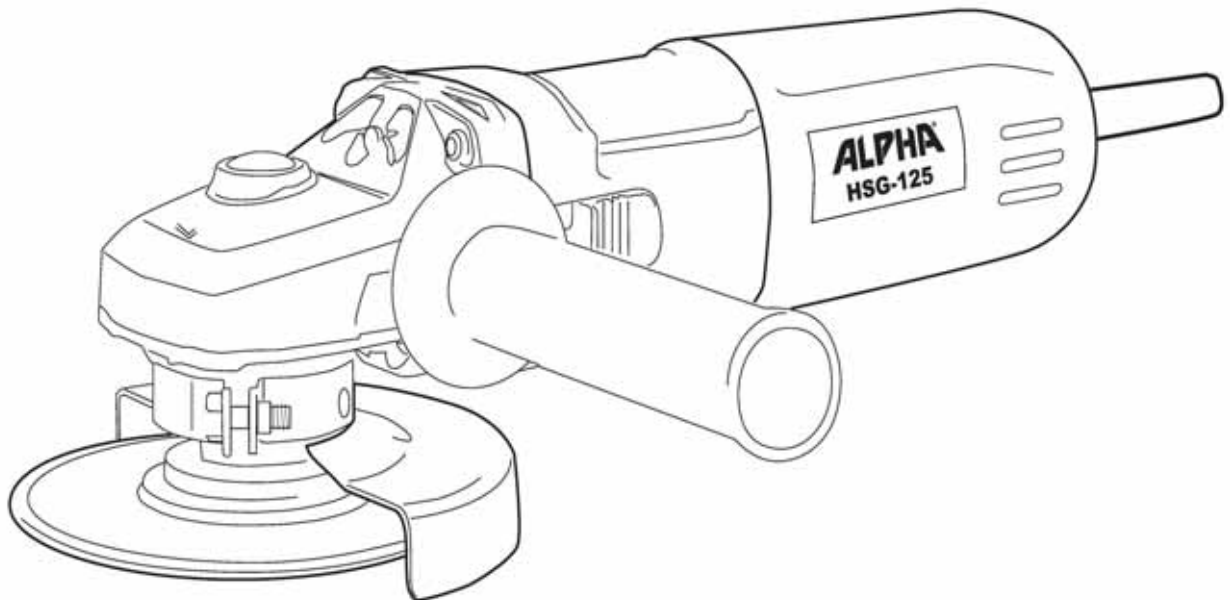

Part No: HSG-125
HSG-225

 **Alpha Professional Tools**[®]

103 Bauer Drive, Oakland, NJ 07436 • 800-648-7229 • Fax: 800-286-0114
www.alpha-tools.com

TABLE OF CONTENTS

High-Speed Angle Grinder Overview.....	3
Specifications.....	3
Accessories.....	4
Components.....	4
Introduction.....	5
About The Symbols.....	5
General Safety Rules.....	6
Work Area	6
Electrical Safety	6
Personal Safety.....	6
Service	7
Specific Safety Rules	8
Use Proper Extension Cords	8
Additional Precautions For Using The High-Speed Angle Grinder.....	9
Safety Advice	9
How To Grind	10
How To Handle The Grinder.....	10
High-Speed Angle Grinder Operation.....	11
Main Connection	11
Switching On And Off.....	11
Before Use.....	12
About Double Insulation.....	13
Laws and Regulations Of Noise Levels	13
Using The Tool	14
Protective Cover Installation	14
Assembling Spindle Attachments.....	15
Disassembling Spindle Attachments.....	16
Checking and Replacing The Carbon Brushes	17
Rear Cover Removal	17
Carbon Brush Holder Removal	18
Carbon Brush Removal.....	19
Cleaning The Commutator	20
Installing The Carbon Brushes.....	20
Angle Grinder Schematic (HSG-125)	21
Angle Grinder Parts List (HSG-125).....	22
Services and Warranty Information	24
Loaner Program.....	24
Need More Information	24
Warranty	24
Alpha® Tool Repair Service.....	25
EC Declaration Of Conformity	26

HIGH-SPEED ANGLE GRINDER OVERVIEW

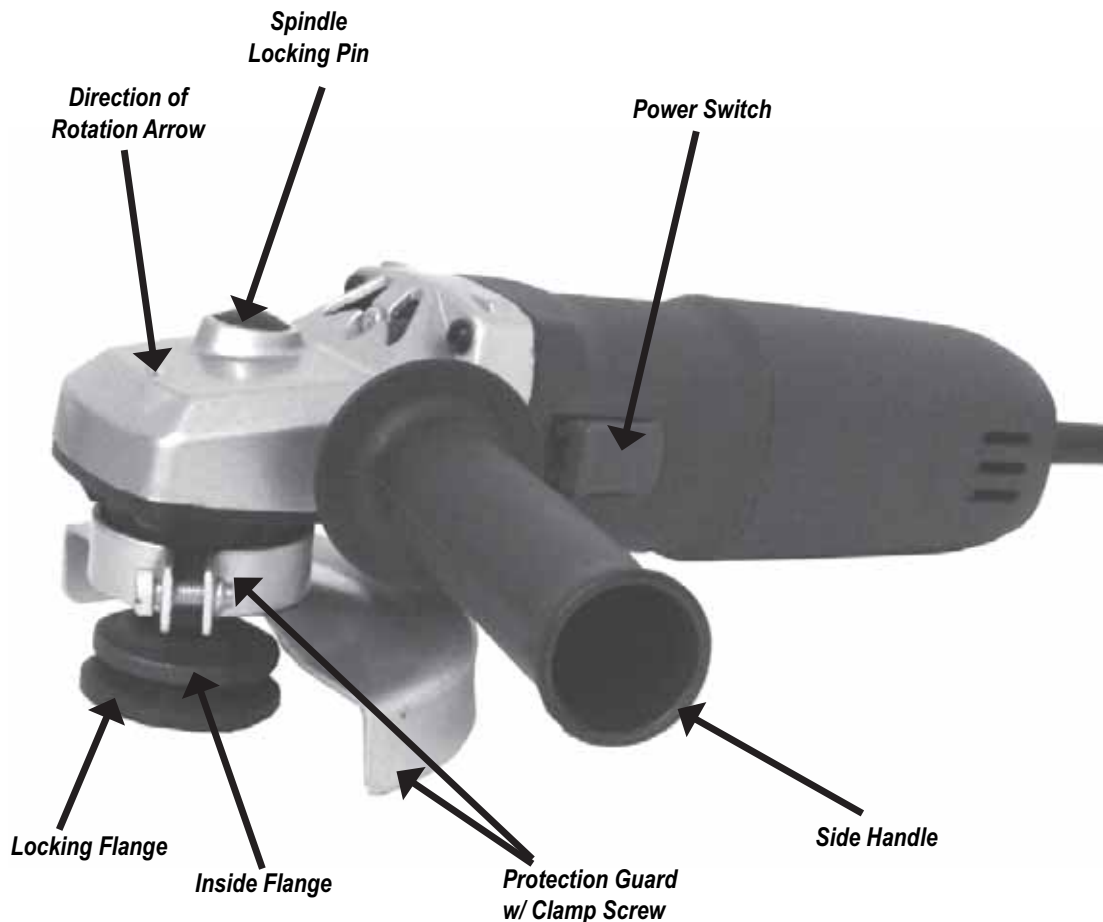

Figure-1

► SPECIFICATIONS

Power Supply.....	Single-Phase AC, 50 / 60 Hz
Rating	115 / 230 Volts
Amperage	7.2A / 3.6A
Power.....	800W
No-load Speed.....	9,700 RPM
Max Disc Size	5" / 125mm
Arbor	5/8"-11 / M14-2
Weight.....	3.52 lbs / 1.6 kg
Cord	8.2ft / 2.5m Single Phase

► ACCESSORIES



Figure-2

COMPONENTS:

1. Protective Cover w/ Clamp Screw (Part No. 130653)
2. Side Handle (Part No. 130433)
3. Inside Flange and Locking Flange Set with 7/8" Arbor (Part No. 136038 & 136039)*
4. Pin spanner Wrench 34 mm (Part No. 130434)
5. Extra Carbon Brush Set (Part No. 136046)
6. Extra Inside Flange & Locking Flange Set with 20mm Arbor (Part No. 136040 & 136041)**

INTRODUCTION

Thank you for purchasing the Alpha® High-Speed Angle Grinder. Please read this instruction manual thoroughly to ensure safety and correct use of this tool. Keep this manual in a place where operators can access it easily whenever necessary.

► ABOUT THE SYMBOLS

According to the hazard level, all safety notes in this manual are classified into “**DANGER**”, “**WARNING**”, and “**CAUTION**”.

 **DANGER!** Death or serious personal injury is imminent when handling this tool incorrectly.

 **WARNING!** There is a possibility of death or serious personal injury when handling this tool incorrectly.

 **CAUTION!** There is a possibility of personal injury or property damage when handling this tool incorrectly.

NOTE: In some situations, failing to observe WARNING notes could result in death or serious personal injury. Be sure to read and observe the safety notes to ensure safety and correct use of the Angle Grinder.

ELECTRICAL SYMBOLS

The following show the symbols used for tool.

V	Volts
A	Amperes
W	Watts
Hz	Hertz
~ or a.c.	Alternating Current
n0	No load speed
.../min	Revolution or reciprocation per minute
kg	Kilograms
mm	Millimeters
lbs	Pounds
	Protective Earth

CAUTION!

The following are important notes for products, operation, and maintenance applicable to this High-Speed Angle Grinder.

GENERAL SAFETY RULES

► **WORK AREA**

- **Keep your work area clean and well lit.** Cluttered benches and dark areas invite accidents.
- **Do not operate power tools in explosive atmospheres, such as in the presence of flammable liquids, gases, or dust.** Power tools may create sparks which may ignite the dust or fumes.
- **Keep bystanders, children, and visitors away while operating a power tool.** Distractions can cause you to lose control.

► **ELECTRICAL SAFETY**

- **Grounded tools must be plugged into an outlet properly installed and grounded in accordance with all codes and ordinances.** Never remove the grounding prong or modify the plug in any way. Do not use any adaptor plugs. Check with a qualified electrician if you are in doubt as to whether the outlet is properly grounded. If the tools should electrically malfunction or break down grounding provides a low resistance path to carry electricity away from the user.
- **Avoid body contact with grounded surfaces, such as pipes, radiators, ranges, and refrigerators.** There is an increased risk of electric shock if your body is grounded.
- **Don't expose power tools to rain or wet conditions.** Water entering a power tool will increase the risk of electric shock.
- **Do not abuse the cord.** Never use the cord to carry the tools or pull the plug from an outlet. Keep cord away from heat, oil, sharp edges, or moving parts. Replace damaged cords immediately. Damaged cords increase the risk of electric shock.
- **When operating a power tool outside, use an outdoor extension cord marked "W-A" or "W".** These cords are rated for outdoor use and reduce the risk of electric shock.

► **PERSONAL SAFETY**

- **Stay alert, watch what you are doing and use common sense when operating a power tool.** Do not use tool while tired or under the influence of drugs, alcohol, or medication. A moment of inattention while operating power tools may result in serious personal injury.
- **Dress properly.** Do not wear loose clothing or jewelry. Contain long hair. Keep your hair, clothing, and gloves away from moving parts. Loose clothes, jewelry, or long hair can be caught in moving parts or drawn into air vents.
- **Avoid accidental starting.** Be sure switch is off before plugging in. Carrying tools with your finger on the switch or plugging in tools that have the switch on, invites accidents.

- **Remove adjusting keys or wrenches before turning the tool on.** A wrench or a key that is left attached to a rotating part of the tool may result in personal injury.
- **Do not overreach.** Keep proper footing and balance at all times. Proper footing and balance enables better control of the tool in unexpected situations. Do not use on a ladder or unstable support.
- **Use safety equipment.** Always wear eye protection. Dust mask, nonskid safety shoes, hard hat, or hearing protection must be used for appropriate conditions.

► **TOOL USE AND CARE**

- **Use clamps or other practical way to secure and support the workpiece to a stable platform.** Holding the work by hand or against your body is unstable and may lead to loss of control.
- **Do not force tool,** use the correct tool for your application. The correct tool will do the job better and safer at the rate for which it is designed.
- **Do not use tool if switch does not turn it on or off.** Any tool that cannot be controlled with the switch is dangerous and must be repaired.
- **Disconnect the plug from power source before making any adjustments, changing accessories, or storing the tool.** Such preventive safety measures reduce the risk of starting the tool accidentally.
- **Store idle tools out of the reach of children and other untrained persons.** Tools are dangerous in the hands of untrained users.
- **Maintain tools with care.** Keep tools sharp and clean for better and safer performance. Follow instructions for lubricating and changing accessories. Inspect the electrical cord periodically and if damaged, have it repaired by authorized service facility. Inspect extension cords periodically and replace if damaged. Keep handles dry, clean and free from oil and grease.
- **Check for damaged parts.** Before using the tool each day, a guard or other part that is damaged should be carefully checked to determine that it will operate properly and perform its intended function. Check for alignment of moving parts, breakage of parts, mounting, and any other conditions that may affect its operation. A guard or other part that is damaged should be properly repaired or replaced by an authorized service center unless otherwise indicated elsewhere in this instruction manual. Have defective switches replaced by authorized service center. Do not use the tool if it cannot be turned on and off by the switch.
- **Use only accessories that are recommended by the manufacturer for your model.** Accessories that may be suitable for one tool, may become hazardous when used on another tool.

► **SERVICE**

- **Tool service must be performed only by qualified repair personnel.** Service or maintenance performed by unqualified personnel could result in a risk of injury.
- **When servicing a tool, use only identical replacement parts.** Follow instructions in the Maintenance section of this manual. Use of unauthorized part or failure to follow Maintenance Instructions may create a risk of electric shock or injury.

► **SPECIFIC SAFETY RULES**

- **Accessories must be rated for at least the speed recommended on the tool warning label.** Wheels and other accessories running over rated speed can fly apart and cause injury.
- **Hold tool by insulated gripping surfaces when performing an operation where the cutting tool may contact hidden wiring or its own cord.** Contact with a “live” wire will make exposed metal parts of the tool “live” and shock the operator.
- **Know your power tool.** Read operator’s manual carefully. Learn its application and limitations, as well as the specific potential hazards related to this tool. Following this rule will reduce the risk of electric shock, fire, or serious injury.
- **Always wear safety glasses with side shields.** Everyday eye-glasses have only impact resistant lenses; they are NOT safety glasses.
- **Protect your lungs.** Wear a face or dust mask if the operation is dusty.
- **Protect your hearing.** Wear hearing protection during extended periods of operation.
- **Inspect tool cords periodically** and if damaged, have repaired at your nearest Factory Service Center or other Authorized Service Organization. Constantly stay aware of cord location.
- **Check damaged parts.** Before further use of the tool, a guard or other part that is damaged should be carefully checked to determine that it will operate properly and perform its intended function. Check for alignment of moving parts, binding of moving parts, breakage of parts, mounting, and any other conditions that may affect its operation. A guard or other part that is damaged should be properly repaired or replaced by an authorized service center.
- **Make sure your extension cord is in good condition.** When using an extension cord, be sure to use one heavy enough to carry the current your product will draw. An undersized cord will cause a drop in line voltage resulting in loss of power and overheating.
- **Inspect for and remove all foreign objects from workpiece before polishing.** Follow this rule will reduce the risk of serious personal injury.
- **Drugs, alcohol, medication, Do not operate tool while under the influence of drugs, alcohol, or any medication.** Follow this rule will reduce the risk of electric shock, fire, or serious personal injury.
- **Keep hands away from polishing area.** Follow this rule will reduce the risk of cuts, scrapes, or serious personal injury.
- **Save these instruction.** Refer to them frequently and use them to instruct others who may use this tool. If you loan someone this tool, loan them these instructions.

► **USE PROPER EXTENSION CORDS**

Use only three-wire extension cords that have three-prong grounding-type plugs and three-pole receptacles that accept the tool’s plug. Make sure your extension cord is in good condition. Replace or repair damaged or worn cord immediately. When using an extension cord, be sure to use one heavy enough to carry the current your product will draw. An undersized cord will cause a drop in line voltage resulting in loss of power and

overheating. Below table shows the correct size to use depending on cord length and nameplate ampere rating. If in doubt, use the next heavier gauge. The smaller the gauge number, the heavier the cord.

Ampere Rating		Total length of cord in feet (115V)		
		25ft	50ft	100ft
More Than	Not More Than	AWG		
0	6	18	16	16
6	10	18	16	14
10	12	16	16	14
12	16	14	12	Not Recommended

ADDITIONAL PRECAUTIONS FOR USING THE HIGH-SPEED ANGLE GRINDER

In addition to the general safety notes described on the preceding pages, please read and observe the following precautionary notes before using the Angle Grinder.

 **DANGER!**

► SAFETY ADVICE

- Please note safety instructions on Page 3-5.
- Do not pierce the motor housing as this could damage the double insulation.
- Always remove plug from the outlet before making any changes to the settings or performing maintenance.
- Ensure the tool is switched off prior to plugging in.
- Keep power cable clear from working area of the machine. The power cable should always lead away from you and behind the operating area.
- Before use, check the machine, cable and plug for any damages or material fatigue. Only authorized service agents should perform repairs.
- After switching off, the machine will not idle down immediately. Allow the machine to come to a complete stop before putting it down.
- Always wear safety glasses and ear protection when working with this machine. It is further recommended to wear safety gloves, apron, as well as sturdy non-slipping shoes.
- Only use grinding discs whose permitted speed is at least as high as the highest no-load speed of the machine.
- Be sure wheels fit tool properly and securely. Do not modify the tool to force fit the wheel. Do not remove wheel cover.

- Check grinding tools before use. The grinding wheel must be properly mounted and turn freely. Perform a test run for at least 30 seconds without any load. Do not use damaged, out of round or vibrating grinding tools.
- Immediately switch off the machine in case of considerable vibrations or if other malfunctions occur. Check the machine in order to find out the cause.
- Always use and store the grinding wheels according to the manufacturer's instructions. The flange bolt must be tightened before starting to work with the machine.
- The work piece must be secured if it is not heavy enough to prevent movement.
- Do not use emery wheel.

HOW TO GRIND

WARNING!

1. During operation, be sure to wear safety glasses and hearing protection.
2. When using this grinder, some of the dust created contains chemicals known to cause cancer, birth defects or other reproductive harm. Some example of these chemicals are:
 - a. Lead based paints
 - b. Crystalline silica found in cement, bricks and other masonry products
 - c. Arsenic and chromium coming from pressure-treated wood
 - d. Pesticides and other chemicals that could have been applied to the work area
3. An approved dust mask that protects the operator against these chemicals should be worn at all times. These dust masks are designed to filter out microscopic particles.

DANGER!

1. If you accidentally drop the machine, do not use until checking that the machine and grinding wheel are not cracked, deformed, or damaged.
2. Grinding wheels and cutting tools used on this tool should be rated at or above the no load rating marked on this tool. Running grinding wheels over their rated speeds can fly apart and cause injury.

CAUTION!

1. Do not press the lock pin while the wheel is rotating.
2. Do not turn the switch on with the lock pin pressed down.

► **HOW TO HANDLE THE GRINDER**

1. It is not necessary to apply more force onto the machine than the force created by the weight of the machine itself.
2. Applying excessive force may damage the grinding wheel and burn up the motor. Such

- action may decrease the rotation speed which reduces the efficiency of the grinder.
3. Hold the tool with both hands while starting; the torque from the motor will cause the tool to jerk.
 4. When the grinding wheel first comes into contact with the work surface or when the wheel is new, make contact slowly.
 5. Keep moving the tool in a circular motion to prevent grooving in the work surface.
 6. Hold the unit tightly to prevent it from walking, and remove the high spots in the work surface from the top down.

HIGH-SPEED ANGLE GRINDER OPERATION

CAUTION!

Always be sure that the tool is switched off and unplugged before adjusting or checking function on tool. This tool is in accordance with IEC 60745, and it can be connected to electrical outlets without ground protection because of double installation. Radio suppression complies with the international standard CISPR 14.

► **MAIN CONNECTION**

Connect only to single-phase AC current supply and only to the main voltage specified on the rating plate.

► **SWITCHING ON AND OFF**

CAUTION!

Before plugging in the tool, always check the working voltage be sure that the voltage specified is on the name plate. Before plugging in the tool, always check to see that the slide switch actuates properly and returns to the “OFF” position when the rear of the slide switch is depressed.

Switching on:

Switch can be locked in “ON” position for operator comfort during extended use. Apply caution when the locking tool is in the “ON” position and maintain firm grasp on tool.

Push sliding switch to the forward position and depress the front part of the switch to lock into position as shown in Figure 3.

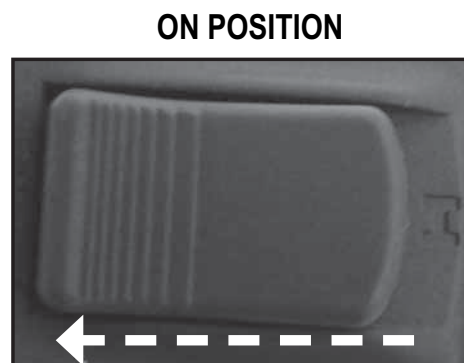

Figure-3

Switching off:

To unlock, depress the back of the sliding switch. The switch will automatically move back as shown in Figure 4.

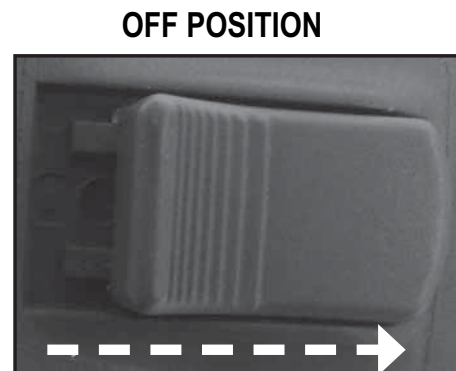

Figure-4

► **BEFORE USE**

 **DANGER!**

Before using the machine, check the following items. In particular, check items 1 to 5 before plugging the power supply cord into the power outlet.

1. Check the working voltage.

- Be sure the voltage specified on the rating plate is the voltage available at the power outlet. If the machine is used with higher voltage than specified, the motor will burnout. Any attempts to do so may damage the polisher and/or cause an accident.

2. Make sure the ON/OFF switch is off.

- If you plug in the power supply cord without realizing that the switch is ON, the machine will start and may cause an accident. Make sure the on/off switch trigger is out and the locking button is not engaged.

3. Inspect the protective wheel cover.

- Do not remove the wheel cover. It will protect you if the grinding wheel breaks.
- Be sure to firmly attach the grinding wheel or any optional accessory.

4. Inspect the grinding wheel.

- Check if you have a specified wheel.
- Never use cracked, chipped, or any damaged wheels.
- Follow the procedures specified in the instruction manual to properly attach applicable accessories.

5. Check the power outlet.

- When the plug of the power supply cord is easily pulled out of the power outlet, the outlet should be replaced. For such task, consult an electrician. If the power outlet is used on a continuous basis, it may overheat and cause accidents.

6. Perform test runs.

 **WARNING!**

1. Before turning the switch ON, make sure the rotating parts are not touching anything. If the switch is turned ON while they are in contact with anything else, the wheel may get damaged and may cause injuries.
2. When a new wheel is attached and the switch is turned ON, keep your body well away from the exposed sides of the wheel for a moment until the machine reaches its full speed.

It is very dangerous to perform grinding operations using cracked, chipped or damaged wheels. Before starting grinding operations, keep the wheel away from anyone nearby. Be sure to perform a few test runs to check whether there are any abnormalities.

Test run duration:

- After replacing a wheel.....at least 3 minutes
- Before starting operations each day.....at least 1 minute

► **ABOUT DOUBLE INSULATION**

This machine is designed with double insulation. Two insulations are used between the conductor and the outer body of the machine. An electric machine with the double insulation highly improves safety from electric shocks. Do not attach or replace unspecified parts and do not assemble incorrectly. This may cause the insulation to malfunction.

► **LAWS AND REGULATIONS OF NOISE LEVELS**

Please observe local laws and regulations regarding noise level in order to avoid disturbing surrounding areas. Install a soundproof wall if required to comply with the local laws and regulations.

USING THE TOOL

► PROTECTIVE COVER INSTALLATION

CAUTION!

The protective cover should be used to prevent the dust and flying debris from hitting the operator or from going inside the tool. Failure to do so can shorten the life of the tool and void the limited warranty.

1. Slide the protective cover onto clamping collar so that the lip on the protective cover fits into the groove on the tool.
2. Position the protective cover with the shield facing backwards as shown in Figure 6. Push down until the protective cover is firmly seated on the clamping collar.

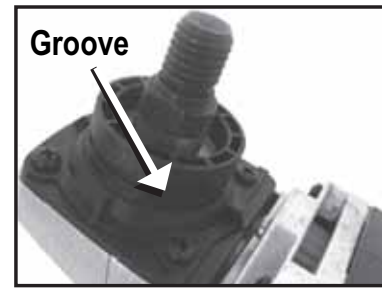

Figure-5



Figure-6



Figure-7

3. Tighten the clamping screw to a snug fit. The protective cover should not be able to move.



Figure-8

► ASSEMBLING SPINDLE ATTACHMENTS

CAUTION!

Do not leave threaded accessories on the spindle of the tool for extended periods of time, as this may result in making it difficult to remove these accessories.

Note: The Alpha® High-Speed Angle Grinder has a 5/8"-11 spindle thread . It comes with two Inside Flange and Locking Flange sets: 20mm Arbor for 4" discs and 7/8" Arbor for 4-1/2" to 5" discs.

To attach an approved spindle attachment to the tool, follow the steps below:

CAUTION!

Always disconnect the plug from the electrical outlet before carrying out any work on the machine.

1. Mount the inside flange. (use the 20mm Inside Flange and Locking Flange Set for 4" discs or the 7/8" Inside Flange and Locking Flange Set for 4-1/2"-5" discs).



Figure-9

2. Add the working tool and then the locking flange as shown in Figure 10 and 11.

Cutting Wheel in photo is not included.

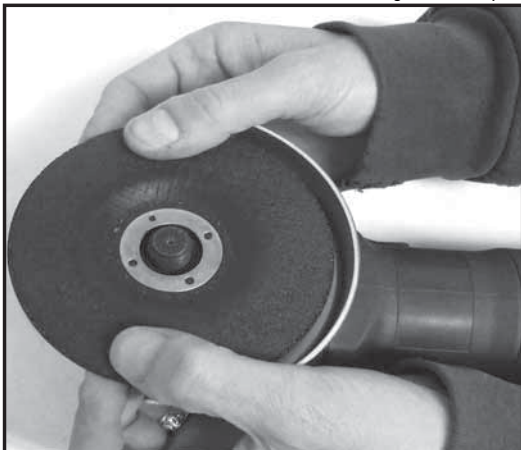

Figure-10

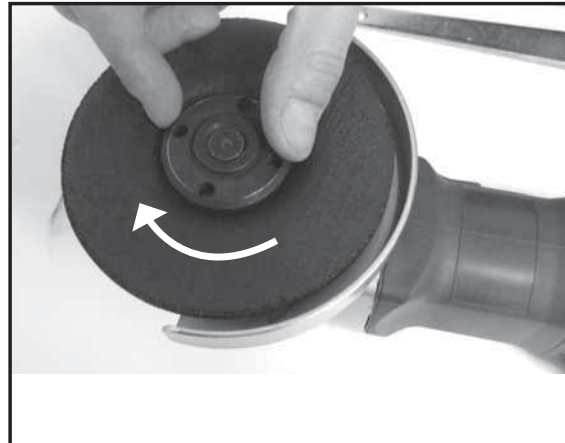

Figure-11

3. While depressing the spindle button, rotate the spindle until the spindle lock button is inserted into the gear, thus locking the spindle in a fixed position.

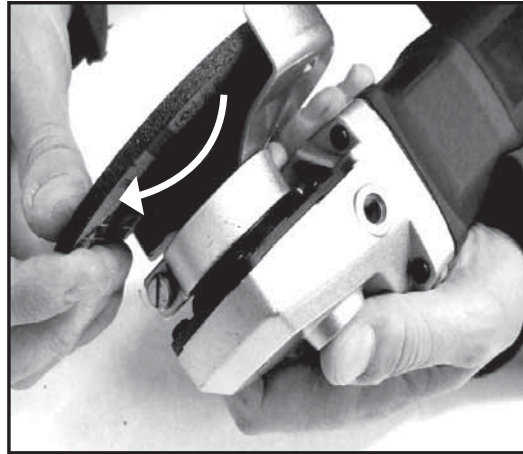

Figure-12

4. With the spindle locked in place, turn the locking flange clockwise until hand-tight.



Figure-13

5. Use the 34mm pin spanner wrench to secure tightly.

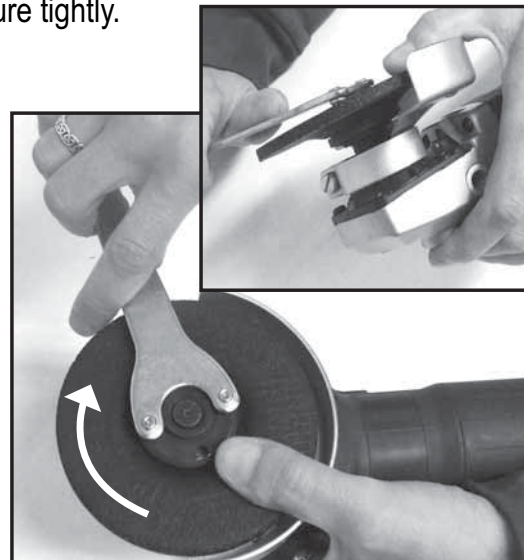

Figure-14

► **DISASSEMBLING SPINDLE ATTACHMENTS**

Please follow the reverse procedure for disassembling the working tool from the grinder.

CHECKING AND REPLACING THE CARBON BRUSHES

In order to keep the tool running correctly, you need to check the carbon brushes after every one hundred hours of use. Carbon brushes wear out over time based on the grinder's usage. If a carbon brush is worn out, it may cause the motor to malfunction or fail to run. The carbon brushes should be replaced before the twisted wire reaches the bottom of the slot.

⚠ DANGER!

Be sure to unplug the power cord from the outlet before servicing the unit, to prevent electrical shock or starting the tool accidentally.

► REAR COVER REMOVAL

1. Remove the rear case screws.

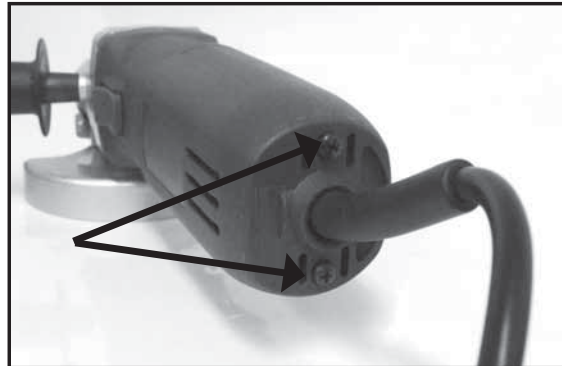

Figure-15

2. Hold grinder with one hand and pull the rear case straight back with the other hand.

NOTE: Do not twist case in a side-to-side motion when pulling back.

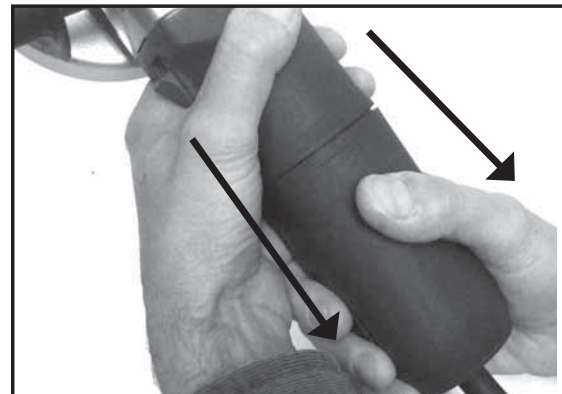

Figure-16

- 2 Pull back the rear case until the carbon brush assembly is exposed.

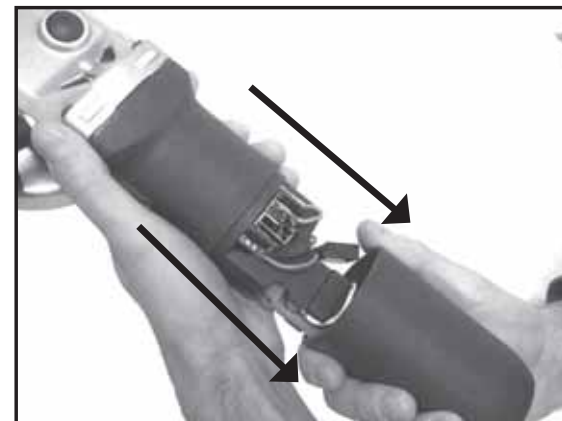

Figure-17

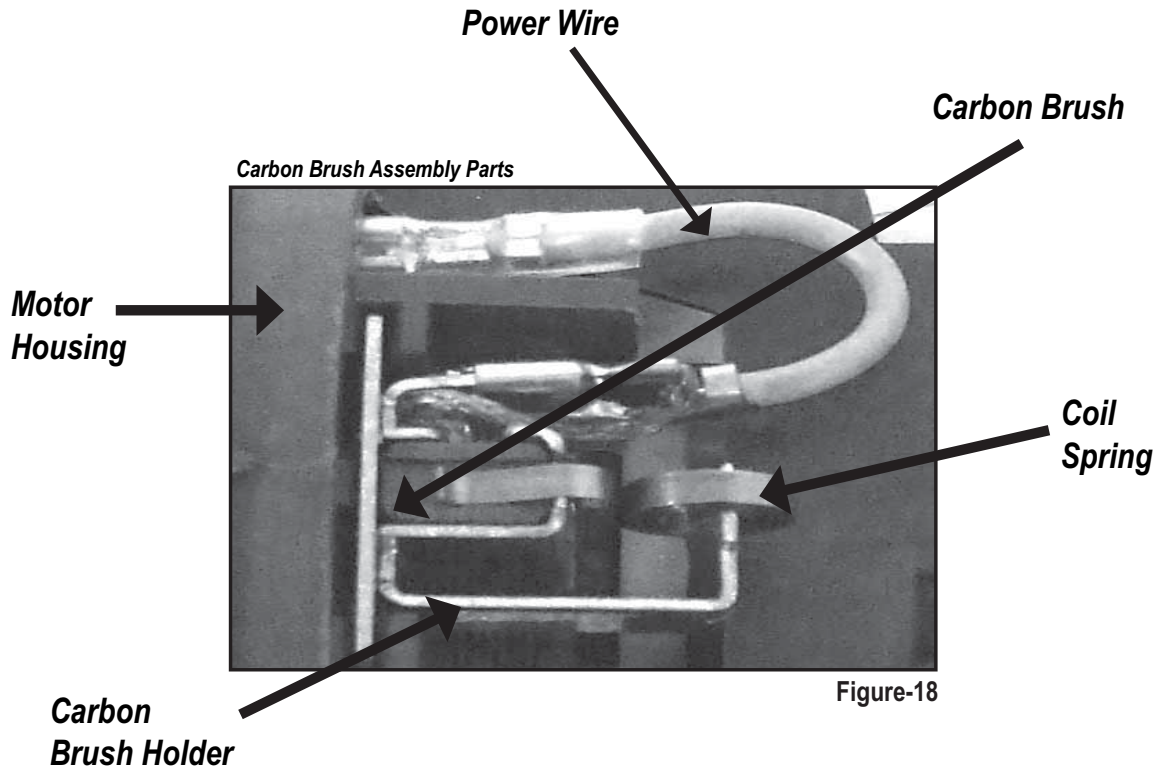

Figure-18

► CARBON BRUSH HOLDER REMOVAL

1. Disconnect the power wire from carbon brush holder.

Note: Each grinder has 2 carbon brushes located on opposite sides of each other.

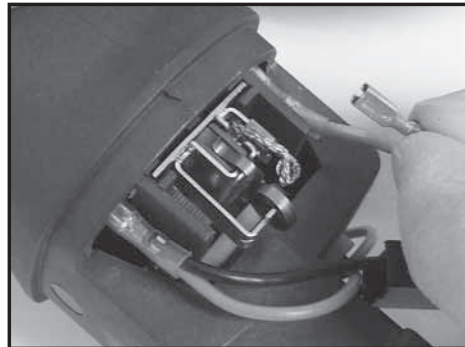

Figure-19

2. Remove the carbon brush holder from the motor housing by pulling the holder out with a pair of needle nose pliers.
3. With the carbon brush holder removed, you can check and clean the armature commutator. The commutator is the contact points that the carbon brushes ride on when the motor is running. (See page 20 for cleaning the commutator)

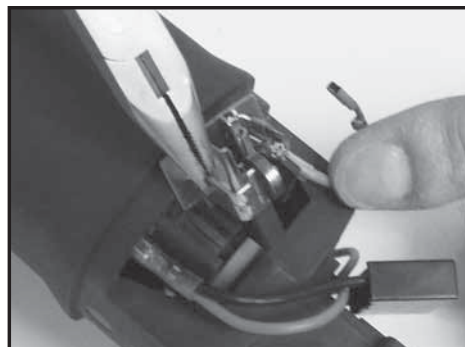

Figure-20

4. Pictured on the left below, is a worn carbon brush in the holder (*Note: the twisted wire is at the end of the slot and the carbon brush is almost flush with holder*). On the right below, is a new carbon brush in the holder.

Worn and New Carbon Brushes

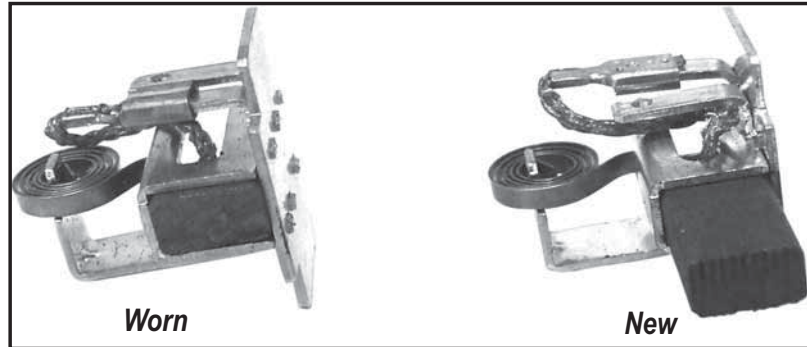

Figure-21

NOTE: Carbon brushes sometime wear at different rates; however, both carbon brushes should be replaced at the same time.

⚠ WARNING!

Replacing the carbon brushes in this unit with non-Alpha® parts could damage the unit, and will void the warranty.

► **CARBON BRUSH REMOVAL**

1. The carbon brush can be removed from the holder by pulling back the carbon brush spring and moving it to the side as shown in the photo on the left below. After reassembly, press the carbon brush in and out of the holder to make sure it moves freely and the twisted wire is not hitting the wire terminal or spring (see photo below on right).

Removing and Installing the Carbon Brush

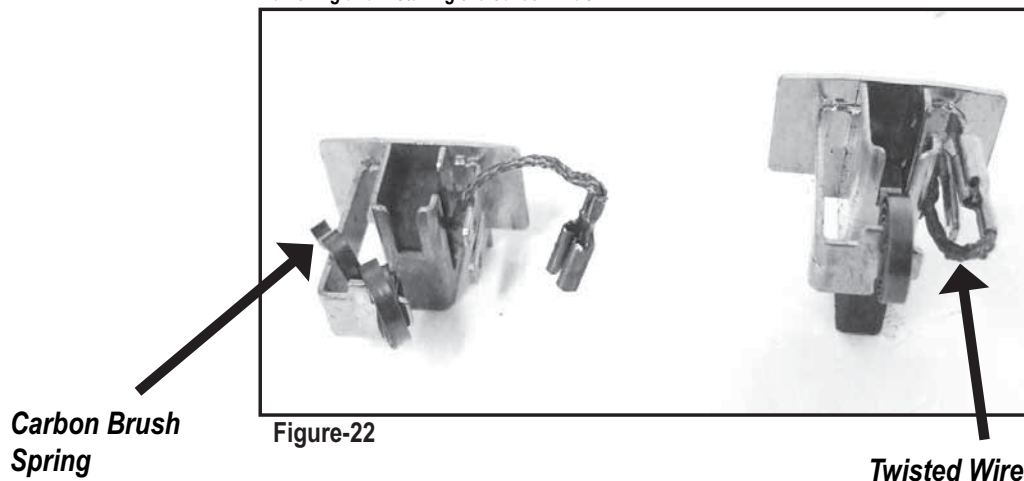

2. Remove the old carbon brush and disconnect the wire terminal. If the inside of the holder is filled with dust, clean it before installing the new carbon brush. Upon installation of the new carbon brush, make sure the twisted wire is in the slot and behind wire terminals on the holder (as in Figure 22 right photo).
3. With the carbon brush holder removed, you can check and clean the armature commutator. The commutator is the contact points that the carbon brushes ride on when the motor is running.

► **CLEANING THE COMMUTATOR**

Clean and Dirty Commutator

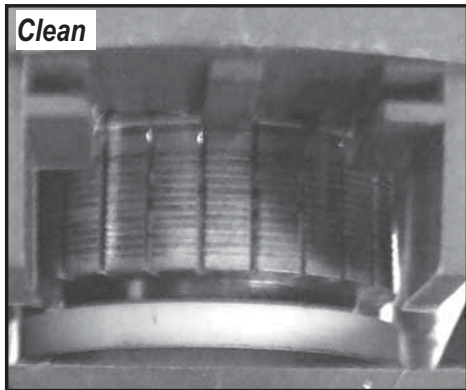

Figure-23

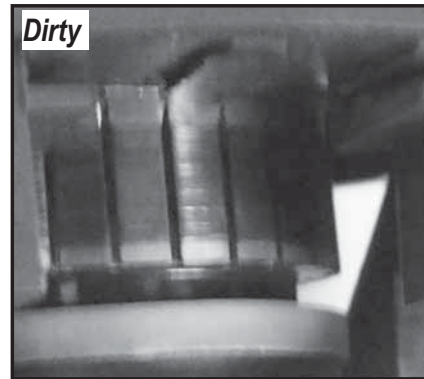

Figure-24

1. The commutator should be clean and shiny. If it is dull and black, you can clean it with a commutator cleaning stone.
2. To clean the commutator, press the commutator cleaning stone against the commutator and rotate the armature by turning the spindle shaft by hand. Continue for a minute or until commutator is clean and shiny.

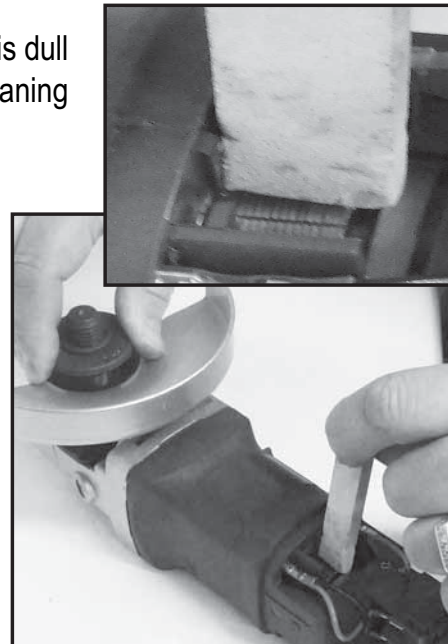
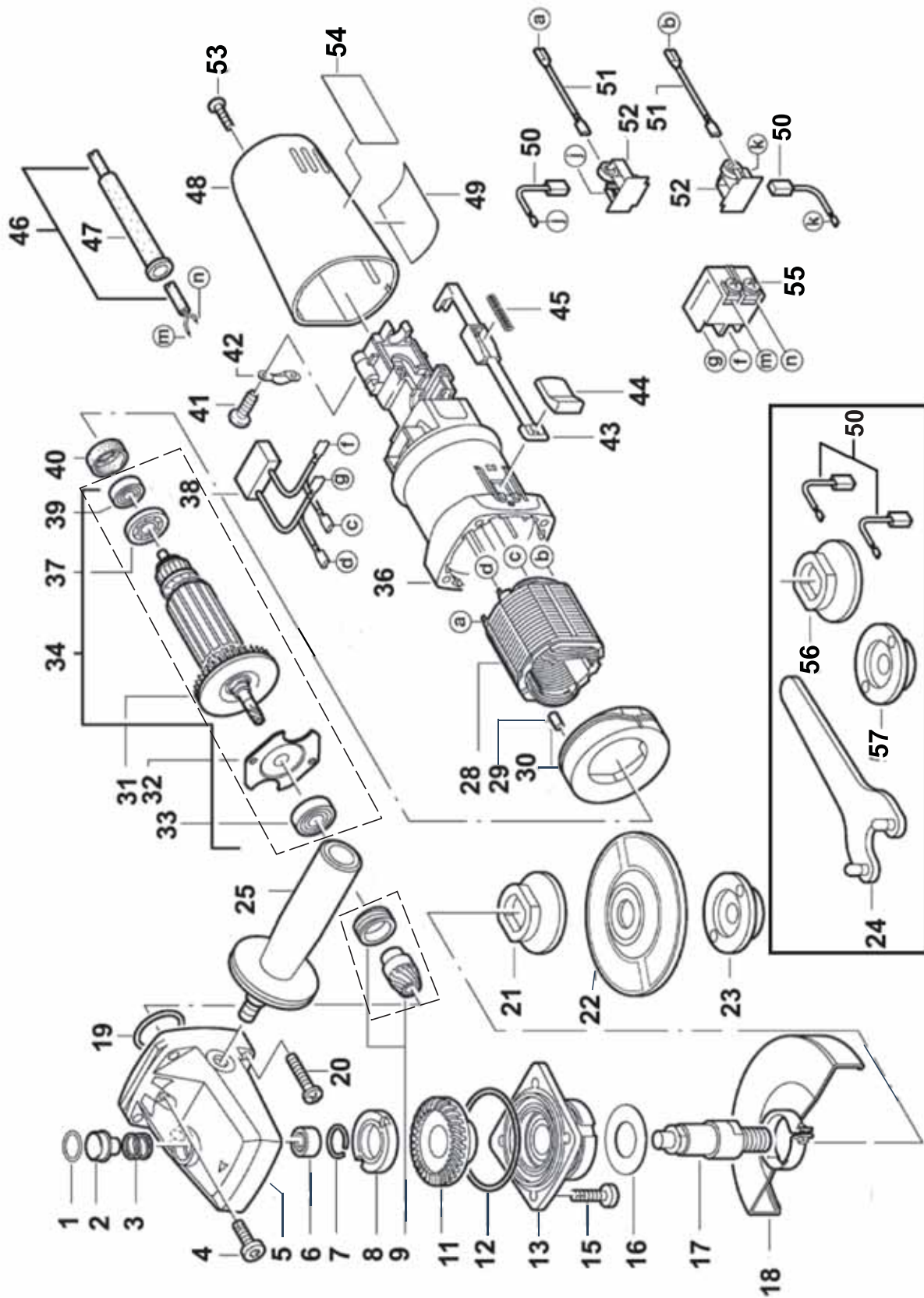

Figure-25

► **INSTALLING THE CARBON BRUSHES**

2. Reinstall the carbon brush holder into the slot on motor housing. Reconnect the power wire, ensuring that the wire path is correct.
3. After both carbon brushes have been replaced, you can reassemble the rear cover. Make sure the power wires are in the tool to prevent pinching of the wires.

ALPHA® HIGH-SPEED ANGLE GRINDER SCHEMATIC (HSG-125)



ALPHA® HIGH-SPEED ANGLE GRINDER PARTS LIST (HSG-125)

DRAWING NO.	PART NO.	DESCRIPTION	PIECES
1	130391	O Ring 16×2	1
2	130390	Lock	1
3	130389	Spring	1
4	130388	Screw M4×7	2
5	130384	Gear Box Assembly	1
6	130458	Needle Bearing HK0709F (7×11×9)	1
7	130450	Snap Ring 13.5×1.2	1
8	130426	Lock Flange	1
9	130420	Small Gear+Oil Wiper	1
11	130442	Big Gear	1
12	130386	O Ring 54×1.5	1
13	130443	Gearbox Cover	2
15	130695	Screw M4×12	4
16	130399	Washer 17.2×30×0.2	1
17	136034	Spindle (5/8"-11)	1
18	130653	Protective Cover	1
19	130387	O Ring 28×2	1
20	131187	Self-tapping Screw 3.9 x 28	4
21	136038	Inside Flange (22.2mm)	1
22	Not Included	Cutting Wheel	1
23	136039	Locking Flange	1
24	130434	Pin Spanner Wrench 34mm	1
25	130433	Side Handle for HSG-125	1
28	136027	Field Coil	1
29	130190	Rubber Insert Φ 5x7.5	2
30	130410	Air Bridge	1
31	130069	Fan	1
32	130418	Flange	1
33	130419	Ball Bearing 609-2RZ/C3 (9×24×7)	1

ALPHA® HIGH-SPEED ANGLE GRINDER PARTS LIST (HSG-125)

DRAWING NO.	PART NO.	DESCRIPTION	PIECES
34	136044	Armature Assembly	1
36	130407	Rear Motor Housing (Blue)	1
37	130376	Insulation Disc	1
38	130657	Condenser Assembly	1
39	130381	Ball Bearing 607-2Z (7×19×6)	1
40	130375	Bearing Sleeve	1
41	130027	Self-tapping Screw 3.9 X9.5	2
42	130026	Cable Clip	1
43	130415	Switch Rod	1
44	130416	Rod Button	1
45	130417	Rod Spring	1
46	136045	Cable	1
47	130428	Cable Sleeve	1
48	130549	Rear Cover	1
49	136035	Rated Plate	1
50	136046	Carbon Brush (2 pc Set)	2
51	130413	Connector (0.045m)	2
52	130411	Brush Holder	2
53	130031	Self-tapping Screw 3.9 x 19	2
54	136036	Brand Label	1
55	135735	Switch	1
56	136040*	Inside Flange (20mm)	2
57	136041*	Locking Flange (20mm)	1

*Only available with the HSG-125.

SERVICES AND WARRANTY INFORMATION

► **LOANER PROGRAM**

Loaner tools can be issued to temporarily replace a tool that is being returned to Alpha® for repair. If more than one tool is being returned for repair, the number of loaner tools provided will be based on availability.

If a loaner tool is required, contact Alpha® Tool Department at (800) 648-7229 to receive a Loaner Tool Application. A valid credit card number must be provided as a security deposit. The credit card will only be charged if the loaner tool is not returned to Alpha® within 30 days. An authorized signature is required for the credit card being used. A second signature is required as an agreement of the overall policy.

► **NEED MORE INFORMATION**

For information on Alpha Professional Tools® complete product line, visit us on the web at www.alpha-tools.com

► **WARRANTY**

Limited Warranty of Alpha® High-Speed Angle Grinder for the USA and Canada ONLY!

Alpha Professional Tools® warrants this product against defects in material and workmanship for a period of 180 days from the date of original retail purchase (proof of purchase required). If Alpha Professional Tools® receives notice of such defects during the warranty period, our obligation assumed under this warranty is limited to the repair or replacement of parts, without charge. This warranty does not apply to tool accessories.

For Warranty Claims: Send complete tool with all your information and details of the problem to your nearest Alpha® Repair Center, transportation prepaid. Do not send tool accessories.

► **ALPHA® TOOL REPAIR SERVICE**

For more information concerning Alpha® tool repair service, please contact the Alpha® regional repair centers listed below:

COMPANY HEADQUARTERS: Alpha Professional Tools®

103 Bauer Drive

Oakland, NJ 07436

Hours of Operation: 8:30 a.m. – 5:00 p.m. EST

Telephone Number: 201-337-3343

Toll-Free Number: 800-648-7229

Website: www.alpha-tools.com

EC DECLARATION OF CONFORMITY

Name of Manufacturer: Alpha Professional Tools®

Address of Manufacturer: 103 Bauer Drive
Oakland, NJ 07436
USA

Herewith declares that:

ELECTRIC HAND TOOL: "High-Speed Angle Grinder"
Make: Alpha Professional Tools®
Type: HSG-125/HSG-225

-Does comply with the provisions of the Low Voltage Directive 73/23EEC amended by 93/68 EEC and Machinery Directive 98/37/EC.

And furthermore declares that:

-The following (parts/clauses of) harmonized standards have been applied:
EN55014-1/ + A1: 2001, EN55014-2/ + A1: 2001, EN61000-3-2:2000, EN61000-3-3/+A1:2001.

Year of affix CE Marking: 2008

Oakland, New Jersey USA



Nao Takahashi
(President)

PRODUCT REGISTRATION CARD

Model No.

Serial No.

Company Name: _____

Name: _____

Address: _____

City: _____ State: _____ Zip: _____

Telephone: _____

Purchase Date: _____

Dealer's Name: _____

Note: Serial & Model Number must be included for proper registration.



Alpha Professional Tools®

(800) 648-7229



Register online at:
www.alpha-tools.com/productregistration.aspx

Mail or Fax to:
Alpha Professional Tools®
103 Bauer Drive, Oakland, NJ 07436
Fax: 800-286-0114



103 Bauer Drive, Oakland, NJ 07436 • 800-648-7229 • Fax: 800-286-0114
www.alpha-tools.com